

# **MS Series Active Studio Monitors**

User Manual

**MIDIPLUS**

# Introduction

Thank you for choosing MS series active studio monitors. This 2-way active monitoring system consists of a silk dome tweeter and carbon fiber cone woofer, along with an efficient Class-D power amplifier. It provides a neutral tool for recording engineers and producers to analyze recordings and optimize mixing. The MS series studio monitors has three inputs: balanced XLR, 1/4" Jack, and unbalanced RCA, as well as Bluetooth connectivity. This makes it suitable for use in both large recording studio and home studio. To ensure proper use and understanding of the monitors, please read the manual carefully and keep it in a safe place for future reference.

## Important Safety Instructions

Please read the following safety instructions before setting up your system. To avoid the possibility of malfunction/ damage to the product, damage to data, or damage to other property. These precautions include, but are not limited to, the following:

1. Read these Instructions.
2. Keep these Instructions.
3. Heed all Warnings.
4. Follow all Instructions.
5. Do not use this apparatus near water.
6. Clean only with a dry cloth.
7. Do not block any ventilation openings. Install in accordance with the manufacturer's instructions.
8. Do not install near any heat sources such as radiators, heat registers, stoves, or other apparatus (including amplifiers) that produce heat.
9. Do not defeat the safety purpose of the polarized or grounding - type plug. A polarized plug has two blades with one wider than the other. A grounding - type plug has two blades and a third grounding prong. The wide blade or the third prong are provided for your safety. If the provided plug does not fit into your outlet, consult an electrician for replacement of the obsolete outlet.
10. Protect the power cord from being walked on or pinched particularly at plugs, convenience receptacles, and the point where they exit from the apparatus.
11. Only use attachments/accessories specified by the manufacturer.
12. Use only with a cart,stand, tripod, bracket, or table specified by the manufacturer, or sold with the apparatus. When a cart is used, use caution when moving the cart/apparatus combination to avoid injury from tip-over.
13. Unplug this apparatus during lightning storms or when unused for long periods of time.
14. Be sure to connect to an appropriate outlet with a protective grounding connection.
15. Exposure to extremely high noise levels may cause permanent hearing loss, please pay attention to protect your hearing.

16. The appliance coupler, or the AC Mains plug, is the AC mains disconnect device and shall remain readily operable after installation
17. The apparatus shall not be exposed to dripping or splashing and that objects filled with liquids, such as vases, shall not be placed on apparatus.
18. Maintain a minimum of 20-30 cm distance around the apparatus for sufficient ventilation;
19. The ventilation should not be impeded by covering the ventilation openings with items such as newspapers, table-cloths, curtains, etc.;
20. Do not place a lighted candles on the apparatus;



The lightning flash with arrowhead symbol within an equilateral triangle is intended to alert the user to the presence of uninsulated "dangerous voltage" within the product's enclosure that may be of sufficient magnitude to constitute a risk of electric shock to persons.



The exclamation point within an equilateral triangle is intended to alert the user of the presence of important operating and maintenance (servicing) instructions in the literature accompanying the appliance.



Only suitable for safe use in non-tropical climates.



Only suitable for safe use in areas below 2000m above sea level.

## Front/Rear Panel Features

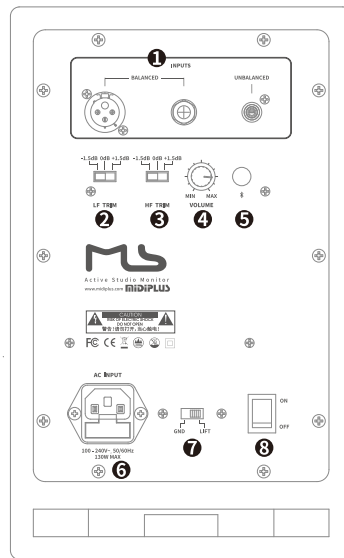
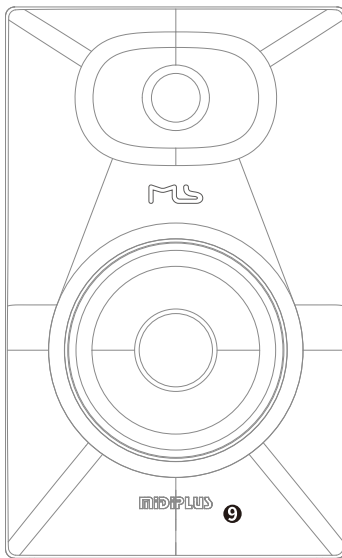

- ① **INPUTS:** Features balanced XLR, 1/4" Jack, and unbalanced RCA inputs.
- ② **LF TRIM switch:** Adjusts the monitor's low frequency response.
- ③ **HF TRIM switch:** Adjusts the monitor's high frequency response.
- ④ **VOLUME control:** Controls the monitor's volume.
- ⑤ **Bluetooth switch:** Turns the monitor's Bluetooth ON or OFF.
- ⑥ **AC INPUT (fuses included):** Plugs the included AC power cord to here first, then insert the AC plug into the AC outlet.
- ⑦ **GND/LIFT switch:** Reduce or remove the ground loop noise.
- ⑧ **Power switch:** Turns the monitor's power ON or OFF<sup>①</sup>.
- ⑨ **Logo LED:** The two colors LED indicators the monitor's power and Bluetooth status.

NOTE: Rapidly turning the power switch ON and OFF may cause the device's electronics to malfunction. It is recommended to wait for at least 3 seconds after turning the power OFF before turning it ON again.

## Connection

The monitor features balanced XLR, 1/4" Jack, and unbalanced RCA inputs, as well as Bluetooth connectivity. To ensure optimal sound quality, use high-quality cables of the shortest length possible. Longer cables increase the chance of noise interference. Balanced cables are more resistant to noise than unbalanced cables.

NOTE: Always turn the power off before inserting and unplugging the cable.

### XLR Input

The XLR input is use for balanced connection. The XLR connector is wired as follows:

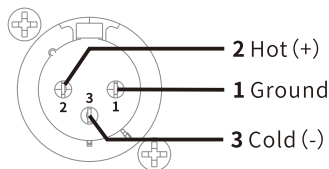

### 1/4" Jack Input

The 1/4" jack input accepts both balanced TRS and unbalanced TS. The balanced TRS connector is wired as follows:

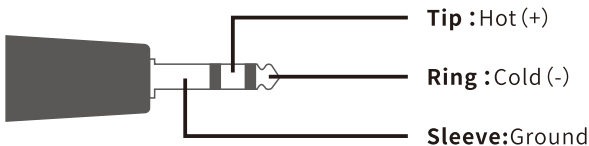

The unbalanced TS connector is wired as follows:

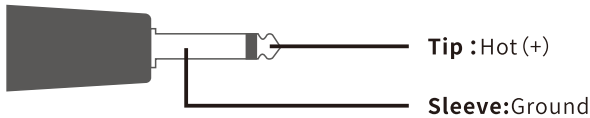

NOTE: The XLR and 1/4" jack input connectors can not be used simultaneously.

## RCA Input

The RCA input is an unbalanced connection. The RCA connector is wired as follows:

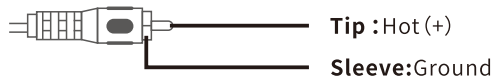

## Bluetooth Connectivity

The MS series monitors features Bluetooth with True Wireless Stereo (TWS) Technology. You can play stereo music on two MS monitors via Bluetooth.

### True Wireless Stereo Pairing

1. Turn on both monitors.
2. Press and hold the Bluetooth button on both monitors for 1 second to activate Bluetooth, you will hear a notification sound from the monitor, the front logo LED will alternate between white and ice blue.
3. If your monitor is connected to a Bluetooth device, disconnect it and ensure that it is not connected.
4. To pair TWS first time, double-click the Bluetooth button on the monitor you have selected as the left channel. Both monitors will emit a notification sound once the pairing is successful. The logo LED on the right channel monitor will turn blue, while the left channel monitor will alternate between white and ice blue. These monitors will automatically pair when Bluetooth is turned on next time.

NOTE: If a monitor is connected to a phone before the TWS is paired, it will be considered the left channel. If both monitors are connected to a phone, the TWS cannot be paired. Please ensure that you pair the TWS before connecting it to a phone.

### Bluetooth Pairing

On your phone or another Bluetooth device, find the "MS Audio" in the list of available devices and connect to it. The monitors will emit a notification sound once the monitor is connected. The front logo LED will turn blue.

## Reset Bluetooth Connections

To reset the Bluetooth connection, press and hold the Bluetooth button for at least 5 seconds. At this point, you can reconnect the TWS and Bluetooth devices.

## Frequency Response Trim Switches

The MS monitors' high-frequency and low-frequency responses can be adjusted up to 1.5dB in either direction to match your room's acoustic characteristics.

**LF TRIM:** Adjust the low-frequency response. Setting attenuates or boosts the range below 800 Hz by 1.5dB. The [0dB] position produces a flat frequency response.

**HF TRIM:** Adjust the high-frequency response. Setting attenuates or boosts the range above 5 kHz by 1.5dB. The [0dB] position produces a flat frequency response.

## The Ground Lift Switch

If you hear a buzzing noise from your monitors caused by ground loop issues, try turning the ground lift switch to another position to reduce or eliminate the noise.

## Technical Specifications

Model	MS5	MS6
Type	Bi-amp 2-way Powered Speaker	
Frequency Response(-3dB)	61 Hz – 21 kHz	56 Hz – 21 kHz
Frequency Response(-6dB)	50 Hz – 22 kHz	47 Hz – 22 kHz
Max SPL@1m (Per unit)	103 dBSPL	105 dBSPL
Crossover Frequency	2kHz	2kHz
HF Driver Speaker	1" Silk dome	
LF Driver Speaker	5.25"Carbon fiber cone	6.5"Carbon fiber cone
Input Connectors	XLR/TRS/RCA	
Input Impedance	8kΩ (Balanced) / 8kΩ (Unbalanced)	
High-Frequency Trim	-1.5dB, 0dB, +1.5dB	
Low-Frequency Trim	-1.5dB, 0dB, +1.5dB	
Ground Switch	Ground/Lift	
Bluetooth	Bluetooth 5.1 with True Wireless Stereo Technology	
Amplifier Output Power	HF: 20W + LF: 50W	HF: 20W + LF: 65W
Amplifier Type	Class-D	
Indicator	White/Ice Blue LED	
Power	AC 100-240V, 50/60Hz	
Dimensions (W*H*D)	186 * 304 * 263 mm	211 * 344 * 305 mm
Weight	4.9 kg	6.3 kg

# Frequency Response Curve

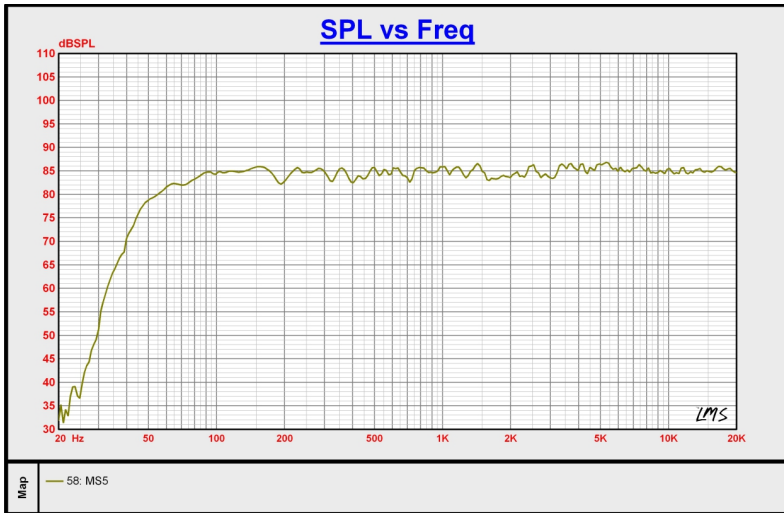

MS5

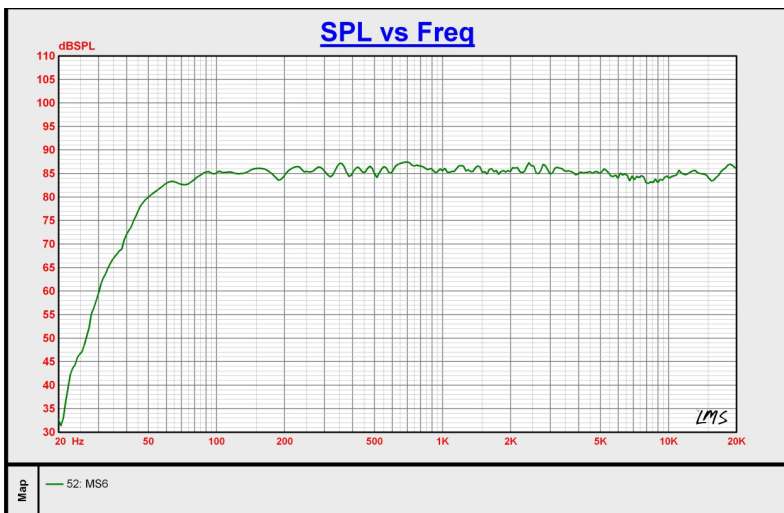

MS6

# Troubleshooting

If there is something wrong with your monitors, try the following basic checks to troubleshoot:

## **No power or front logo LED doesn't light**

- Check the AC outlet is live.
- Check the power cord is plugged properly.
- Check the power switch is turned on.

## **No sound**

- Check the cable is connected properly.
- Check the source device is supplying an audio signal.
- The volume control setting might be too low, try to turn up the volume gently.
- Check the XLR and 1/4" jack input are inserted cables, make sure only use one at a time.

## **Distorted sound or noise**

- The signal cable might be corroded, shorted, please try to replace the cable.
- Check the signal level from the source device is too high.
- Check the signal from the source device is distorted
- Check the Ground Lift switch setting, please try turning to another position.

## **Bluetooth cannot connect or pair**

- Make sure the Bluetooth is activated, please check the front logo LED whether alternate between white and ice blue.
- Make sure the Bluetooth is not connected by other device. Please press and hold the Bluetooth button for at least 5 seconds to reset the Bluetooth connection.



# MS 系列 有源监听音箱

用户手册

**MIDIPLUS**

# 前言

非常感谢您选择MS系列有源监听音箱产品。本产品是由丝膜球顶高音单元和碳纤维锥盆低音单元以及高效的Class-D功放组成的2分频有源监听系统,为录音师或制作人提供了一个中立的工具来分析录音和优化混音。它具备平衡式XLR、TRS以及非平衡RCA三种输入接口以及蓝牙连接,无论是大型录音棚还是小型工作室都能胜任。为了让您更好的理解和使用本监听音箱,请在开始使用之前仔细阅读本说明书,并妥善保管,以便随时查阅。

## 重要安全说明

**在安装使用音箱之前,请仔细阅读并遵循以下安全须知,以免损坏设备或造成人身伤害。安全须知包括但不限于以下内容:**

1. 请阅读这些说明。
2. 请妥善保管这些说明。
3. 请注意所有的警示。
4. 请遵守所有的说明。
5. 请勿在靠近水的地方使用本产品。
6. 请用干布清洁本产品。
7. 请勿堵塞通风口。
8. 请勿将本产品安装在热源附近。
9. 请勿移除极性插头或接地插头的安全装置,接地插头是由两个插头及一个接地头构成。
10. 妥善保护电源线,使其不被踩踏或刺破。
11. 请只使用制造商指定的附属设备和配件。
12. 若使用手推车来搬运产品,请注意安全放置产品,以避免手推车和产品倾倒而受伤。
13. 遇闪电雷鸣或长期不使用本产品时,请拔掉电源插头。
14. 本产品连接电源时一定要要有接地保护。
15. 长期使用过大的音量可能会造成听力的永久性受损,请注意保护好听力。
16. 本产品断开装置为电源插头,配备给本产品使用的电源插座应当装在本产品附近,且应当便于操作,不得被其他物体阻挡。
17. 请避免有水滴溅或喷洒到产品上面,请不要把任何带液体的器皿(如花瓶等)放在产品上。
18. 为确保产品工作时的散热,请让产品与四周物体之间的距离至少在20~30厘米以上。
19. 应确保产品的通风,不可用报纸,清洁布及其他织物等类似物体盖住音箱倒相孔。
20. 请不要将点燃的蜡烛等放在产品上。



**警告:为避免触电危险,请勿打开后盖及其他部件。产品内部没有可供用户维修的部件。请将维修事项交由合格的专业人员进行。**



等边三角形内带有箭头的闪电符号旨在提醒用户产品外壳内存在未绝缘的危险电压，该电压的大小可能足以构成触电危险。



等边三角形内的感叹号旨在提醒用户设备随附的文献中存在重要的操作和维护说明。



仅适用于非热带气候条件下安全使用。



仅适用于海拔2000米以下地区安全使用。

## 前/后面板功能

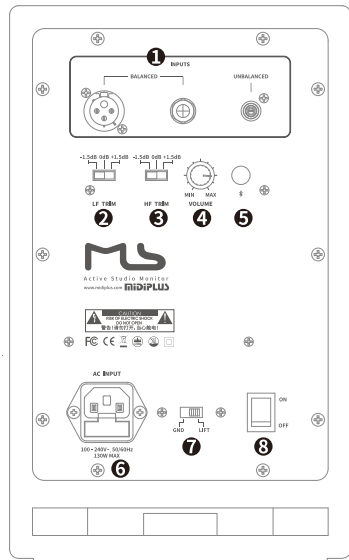
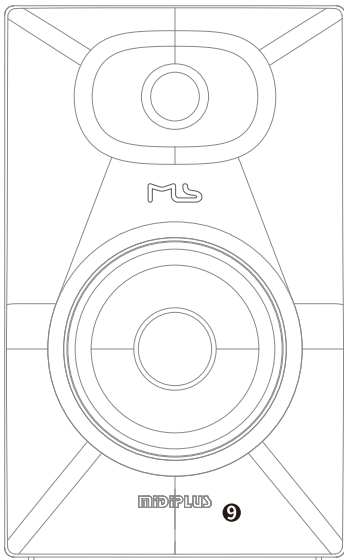

- ❶ 输入接口：提供了平衡XLR和平衡1/4" TRS以及非平衡RCA三种输入接口。
- ❷ 低频调节：调节音箱的低频响应。
- ❸ 高频调节：调节音箱的高频响应。
- ❹ 音量旋钮：控制音箱的音量。
- ❺ 蓝牙开关：打开或关闭音箱的蓝牙连接功能。
- ❻ 交流输入接口（内含熔断器）：用附带的交流电源线连接到此处，然后再连接至交流电源插座。
- ❼ 浮地开关：可隔绝由于接地环路引起的共地噪声
- ❽ 电源开关：打开或关闭音箱的电源<sup>①</sup>。
- ❾ 徽标：双色徽标用于电源指示以及蓝牙状态指示。

注<sup>①</sup>：频繁快速打开和关闭电源会使产品出现故障，关闭电源后请等待3秒或更长时间再打开电源。

# 连接音箱

本产品具备平衡式XLR、1/4" TRS以及非平衡RCA三种输入接口以及蓝牙无线连接。使用线缆连接时,请使用符合要求的线缆将MS系列音箱连接到您的声源器材<sup>②</sup>。推荐使用有效长度尽可能短的平衡式线缆,因线缆越长越容易受到干扰而产生噪音,而平衡式线缆则比非平衡线缆具备更好的抗干扰性。

注②:插拔线缆前请务必关闭音箱电源。

## XLR接口

XLR接口主要用于进行平衡连接,使用的线缆需符合以下引线定义:

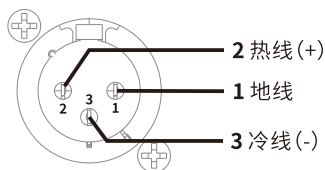

## 1/4"接口

MS音箱的1/4"接口<sup>③</sup>可以进行TRS平衡连接或TS非平衡连接,您可以根据您的声源器材选择其中一种连接方式:

TRS平衡线缆引线定义:

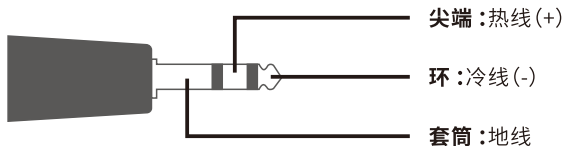

TS非平衡线缆引线定义:

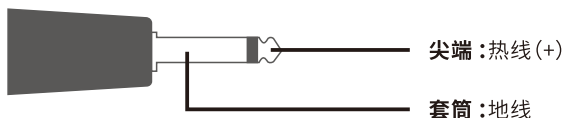

注③:XLR和1/4"接口不能同时使用

## RCA接口

RCA输出属于非平衡式连接, 线缆引线定义如下:

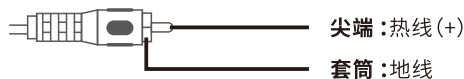

## 蓝牙连接

MS音箱内置了具备TWS功能的蓝牙模块, 使用两个音箱时可以通过蓝牙配对成真无线立体声 (TWS) 音箱, 然后通过手机连接蓝牙即可实现2.0立体声的播放。

### 蓝牙TWS配对

1. 打开两只音箱的电源;
2. 分别长按两只音箱的蓝牙开关约1秒钟打开蓝牙广播, 音箱播放提示音且Logo灯呈白色/冰蓝色灯呼吸交替变换;
3. 如您的音箱已被手机或其他蓝牙设备连接, 请断开并确保您的音箱没有被手机或其他蓝牙设备连接<sup>④</sup>;
4. 首次配对请双击您选择作为左声道音箱的蓝牙开关, 当两只音箱相继播放连接提示音即完成TWS配对, 此时右声道音箱的Logo灯常亮冰蓝色, 而左声道音箱Logo灯仍呈白色/冰蓝色灯呼吸交替变换。配对成功后, 下次开机打开蓝牙后会自动连接。

注<sup>④</sup>: 请在TWS配对成功后再使用手机或其他蓝牙设备与音箱配对。如果在TWS配对前, 其中一只音箱被手机连接了, 则该音箱会默认作为左声道。如果两只音箱都被手机连接则无法配对TWS。

### 蓝牙设备配对

在手机或其他蓝牙设备上的可连接设备列表中找到名称为“MS Audio”并点击连接, 当音箱播放连接提示音即连接成功, 音箱的Logo灯将常亮冰蓝色。

### 重置蓝牙连接

如果在某些情况下需要重新配对连接蓝牙, 可以按下蓝牙按键5秒以上强制断开蓝牙连接并进入待连接状态, 此时您可以重新配对TWS和蓝牙设备。

### 频响调节开关

MS音箱的高、低频响应都有-1.5dB, 0dB和+1.5dB三档可调, 可以根据您的房间声学特性对音箱的频率响应进行微调。

LF TRIM: 调节低频响应, 可将800Hz以下的频段衰减或提升1.5dB, 0dB位置将保持曲线平坦的频率响应。

HF TRIM: 调节高频响应, 可将5kHz以上的频段衰减或提升1.5dB, 0dB位置将保持曲线平坦的频率响应。

# 浮地开关

如果您的监听音箱出现由于接地回路问题而引起的“嗡嗡”噪声，您可以尝试将浮地开关拨至另一端位置以减少或消除这种噪声。

## 技术规格

型号	MS5	MS6
类型	2分频有源音箱	
频响范围(-3dB)	61 Hz – 21 kHz	56 Hz – 21 kHz
频响范围(-6dB)	50 Hz – 22 kHz	47 Hz – 22 kHz
最大声压级@1m(单只)	103 dBSPL	105 dBSPL
分频点	2kHz	2kHz
高音单元	1"丝膜软球顶	
低音单元	5.25"碳纤维锥盆	6.5"碳纤维锥盆
输入接口	XLR/TRS/RCA	
输入阻抗	8kΩ(平衡)/ 8kΩ(非平衡)	
高频调节	-1.5dB, 0dB, +1.5dB	
低频调节	-1.5dB, 0dB, +1.5dB	
接地开关	接地/浮地	
蓝牙	Bluetooth 5.1 支持TWS真无线立体声	
功放输出功率	高频:20W + 低频:50W	高频:20W + 低频:65W
功放类型	Class-D	
Logo指示灯	白色/冰蓝色 LED	
电源	交流100-240V, 50/60赫兹	
尺寸(W*H*D)	186 * 304 * 263 毫米	211 * 344 * 305 毫米
重量(只)	4.9公斤	6.3公斤

# 频响曲线

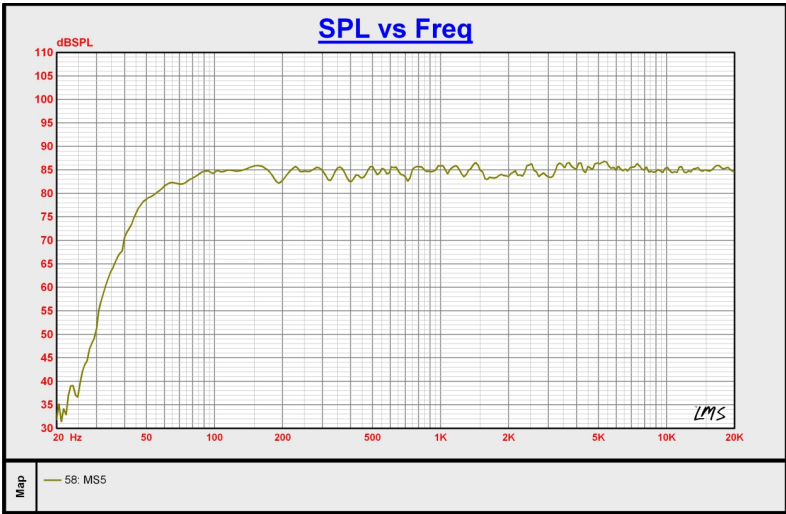

MS5 频响曲线

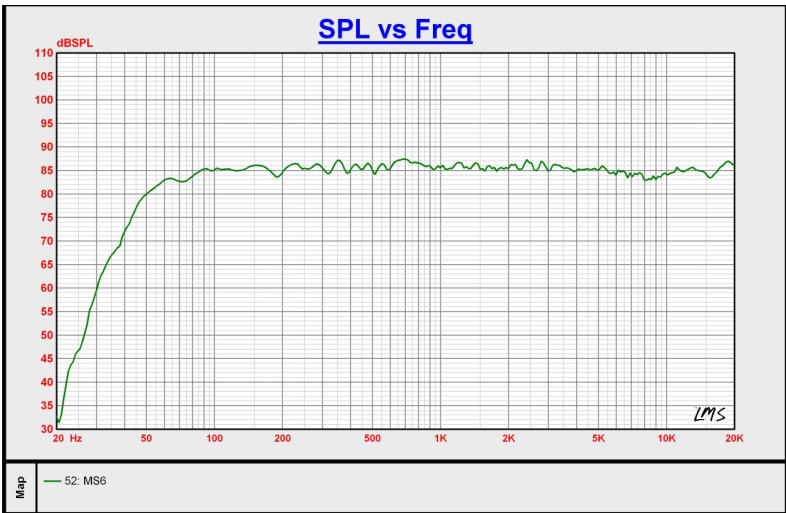

MS6 频响曲线

## 故障排除

如果您的音箱出现某些问题，请尝试以下基本检查以排除故障：

### 电源无法打开或面板徽标不亮

- 检查交流电源插座是否通电。
- 检查电源线是否已正确连接。
- 检查电源开关是否已经拨至“ON”位置。

### 没有声音

- 检查信号线缆否已正确连接。
- 检查声源输出是否有提供音频信号。
- 检查音量旋钮是否设置太小音量，可尝试缓慢调大音量。
- 检查XLR和1/4"接口是否同时插入了线缆，只能使用其中一种。

### 声音失真或有噪声

- 信号线缆否有短路、断路，请尝试更换线缆。
- 检查声源输出信号电平是否太高。
- 检查声源输出信号是否失真。
- 检查音箱浮地开关是否在“GND”或“LIFT”位置，请尝试将其拨至另一边。

### 蓝牙无法配对或无法连接

- 确保音箱的蓝牙已经开启广播，请检查面板徽标是否呈白色/冰蓝色灯呼吸交替变换。
- 确保蓝牙没有被其他设备连接，请长按蓝牙开关5秒以上以重置蓝牙连接状态。